

TVS Diodes

Transient Voltage Suppression Diodes

P4SMF Series

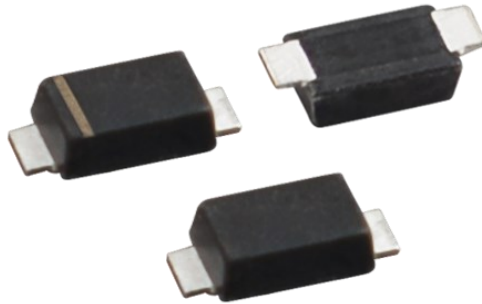

Description

The P4SMF series is designed specifically to protect sensitive electronic equipment from voltage transients induced by lightning and other transient voltage events. P4SMF package is 50% smaller in footprint when compare to SMA package and delivering one of the low height profiles (1.2 mm) in the industry.

Applications

- Communication Equipment
- Security & Protection
- Industrial Control Equipment
- Power Supply
- Automotive Electronics
- New Energy
- Lightning Protection

Functional Diagram

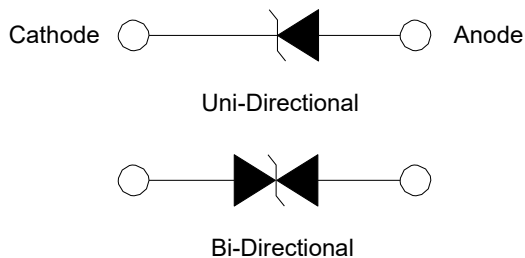

Features

- 400 W peak pulse capability at 10/1000 μ s waveform, repetition rate (duty cycles):0.01%
- Compatible with industrial standard package SOD-123FL
- Low profile: maximum height of 1.2 mm.
- Low inductance, excellent clamping capability
- For surface mounted applications to optimize board space
- High temperature to reflow soldering guaranteed: 260°C / 30 sec
- Typical failure mode is short from over-specified voltage or current
- Whisker test is conducted based on JEDEC JESD201A per its table 4a and 4c
- IEC-61000-4-2 ESD 30 kV (Air), 30 kV (Contact)
- ESD protection of data lines in accordance with IEC 61000-4-2
- EFT protection of data lines in accordance with IEC 61000-4-4
- Fast response time: typically less than 1.0 ns from 0 Volts to V_{BR} min
- Built-in strain relief
- Plastic package is flammability rated V-0 per UL 94
- Meet MSL level1, per J-STD-020
- Matte tin lead-free plated
- Halogen-free and RoHS compliant
- Pb-free E3 means 2nd level interconnect is Pb-free and the terminal finish material is tin(Sn) (IPC/ JEDEC J-STD-609A.01)

TVS Diodes

Transient Voltage Suppression Diodes

P4SMF Series

Package Outline Dimensions (SOD-123FL)

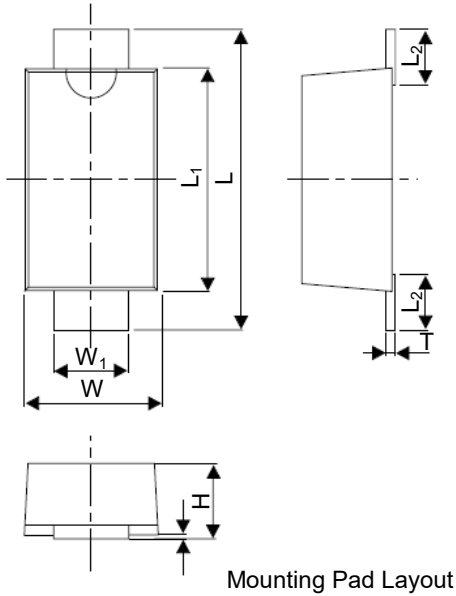

Symbol	Millimeters		Inches	
	Min.	Max.	Min.	Max.
L ₁	2.70	2.90	0.1060	0.1140
L	3.40	3.90	0.1339	0.1535
W ₁	0.70	1.20	0.0275	0.0472
W	1.50	2.00	0.0591	0.0787
L ₂	0.35	0.90	0.0138	0.0354
T	0.05	0.26	0.0020	0.0102
H	1.20	1.40	0.0470	0.0550

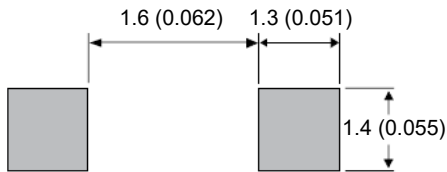

SOD-123FL

Maximum Ratings and Characteristics

(T_A = 25 °C unless otherwise specified.)

Parameter	Symbol	Value	Unit
Peak Pulse Power Dissipation at T _A =25 °C , 10/1000 μs current waveform	P _{PPM}	400	W
Power Dissipation On Infinite Heat Sink at T _L =50 °C	P _D	1	W
Thermal Resistance Junction- to- Ambient	R _{θJA}	220	°C / W
Thermal Resistance Junction- to- Lead	R _{θJL}	100	°C / W
Operating Temperature Range	T _J	-55 to 150	°C
Storage Temperature Range	T _{STG}	-55 to 175	°C

Notes

1. Non-repetitive current pulse, per Fig. 4 and derated above T_J(initial)=25 °C per Fig. 3.

TVS Diodes

Transient Voltage Suppression Diodes

P4SMF Series

Part Numbering System

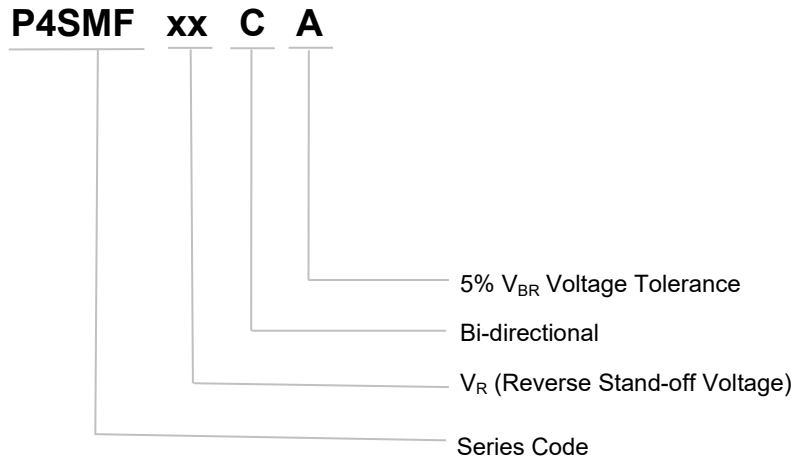

Marking

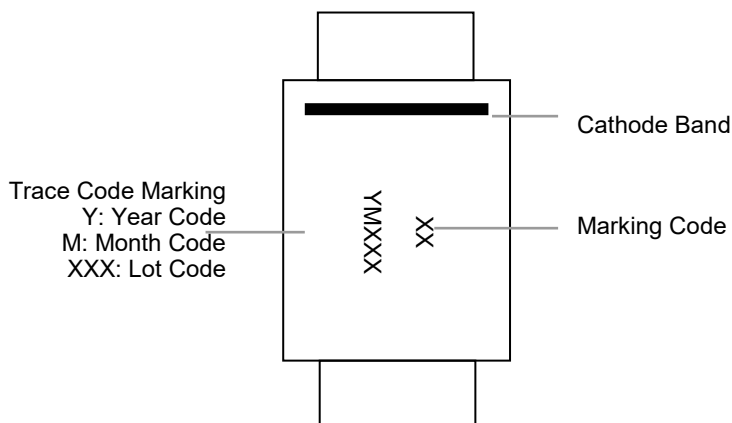

TVS Diodes

Transient Voltage Suppression Diodes

P4SMF Series

Electrical Characteristics (T_A=25 °C unless otherwise noted)

Part Number		Device Marking Code		Breakdown Voltage V _{BR} @I _T		Test Current I _T	Reverse Stand-off Voltage V _R	Max. Reverse Leakage I _R @V _R	Max. Peak Pulse Current I _{PPM}	Max. Clamping Voltage V _C @I _{PPM}
				Min	Max					
Uni	Bi	Uni	Bi	(V)		(mA)	(V)	(μA)	(A)	(V)
P4SMF5.0A	-	KE	-	6.40	7.00	10	5.00	300.00	43.50	9.20
P4SMF6.0A	-	KG	-	6.67	7.37	10	6.00	300.00	38.80	10.30
P4SMF6.5A	-	KK	-	7.22	7.98	10	6.50	200.00	35.70	11.20
P4SMF7.0A	-	KM	-	7.78	8.60	10	7.00	100.00	33.30	12.00
P4SMF7.5A	-	KP	-	8.33	9.21	1	7.50	50.00	31.00	12.90
P4SMF8.0A	-	KR	-	8.89	9.83	1	8.00	20.00	29.40	13.60
P4SMF8.5A	-	KT	-	9.44	10.40	1	8.50	10.00	27.80	14.40
P4SMF9.0A	P4SMF9.0CA	KV	AV	10.00	11.10	1	9.00	2.00	26.00	15.40
P4SMF10A	P4SMF10CA	KX	AX	11.10	12.30	1	10.00	2.00	23.50	17.00
P4SMF11A	P4SMF11CA	KZ	AZ	12.20	13.50	1	11.00	2.00	22.00	18.20
P4SMF12A	P4SMF12CA	LE	BE	13.30	14.70	1	12.00	2.00	20.10	19.90
P4SMF13A	P4SMF13CA	LG	BG	14.40	15.90	1	13.00	1.00	18.60	21.50
P4SMF14A	P4SMF14CA	LK	BK	15.60	17.20	1	14.00	1.00	17.20	23.20
P4SMF15A	P4SMF15CA	LM	BM	16.70	18.50	1	15.00	1.00	16.40	24.40
P4SMF16A	P4SMF16CA	LP	BP	17.80	19.70	1	16.00	1.00	15.40	26.00
P4SMF17A	P4SMF17CA	LR	BR	18.90	20.90	1	17.00	1.00	14.50	27.60
P4SMF18A	P4SMF18CA	LT	BT	20.00	22.10	1	18.00	1.00	13.70	29.20
P4SMF20A	P4SMF20CA	LV	BV	22.20	24.50	1	20.00	1.00	12.30	32.40
P4SMF22A	P4SMF22CA	LX	BX	24.40	26.90	1	22.00	1.00	11.30	35.50
P4SMF24A	P4SMF24CA	LZ	BZ	26.70	29.50	1	24.00	1.00	10.30	38.90
P4SMF26A	P4SMF26CA	ME	CE	28.90	31.90	1	26.00	1.00	9.50	42.10
P4SMF28A	P4SMF28CA	MG	CG	31.10	34.40	1	28.00	1.00	8.80	45.40
P4SMF30A	P4SMF30CA	MK	CK	33.30	36.80	1	30.00	1.00	8.30	48.40
P4SMF33A	P4SMF33CA	MM	CM	36.70	40.60	1	33.00	1.00	7.50	53.30
P4SMF36A	P4SMF36CA	MP	CP	40.00	44.20	1	36.00	1.00	6.90	58.10

TVS Diodes

Transient Voltage Suppression Diodes

P4SMF Series

Part Number		Device Marking Code		Breakdown Voltage $V_{BR}@I_T$		Test Current I_T	Reverse Stand-off Voltage V_R	Max. Reverse Leakage $I_R@V_R$	Max. Peak Pulse Current I_{PPM}	Max. Clamping Voltage $V_C@I_{PPM}$
				Min	Max					
Uni	Bi	Uni	Bi	(V)		(mA)	(V)	(μ A)	(A)	(V)
P4SMF40A	P4SMF40CA	MR	CR	44.40	49.10	1	40.00	1.00	6.20	64.50
P4SMF43A	P4SMF43CA	MT	CT	47.80	52.80	1	43.00	1.00	5.80	69.40
P4SMF45A	P4SMF45CA	MV	CV	50.00	55.30	1	45.00	1.00	5.50	72.70
P4SMF48A	P4SMF48CA	MX	CX	53.30	58.90	1	48.00	1.00	5.20	77.40
P4SMF51A	P4SMF51CA	MZ	CZ	56.70	62.70	1	51.00	1.00	4.90	82.40
P4SMF54A	-	NE	-	60.00	66.30	1	54.00	1.00	4.60	87.10
P4SMF58A	-	NG	-	64.40	71.20	1	58.00	1.00	4.30	93.60
P4SMF60A	-	NK	-	66.70	73.70	1	60.00	1.00	4.10	96.80
P4SMF64A	-	NM	-	71.10	78.60	1	64.00	1.00	2.90	103.00
P4SMF70A	-	NP	-	77.80	86.00	1	70.00	1.00	3.50	113.00
P4SMF75A	-	NR	-	83.30	92.10	1	75.00	1.00	3.30	121.00
P4SMF78A	-	NT	-	86.70	95.80	1	78.00	1.00	3.20	126.00
P4SMF85A	-	NV	-	94.40	104.00	1	85.00	1.00	2.90	137.00

Notes:

1. V_{BR} measured after I_T applied for 300 μ s, I_T = square wave pulse or equivalent.
2. Surge current waveform per 10/1000 μ s exponential wave and derated per Fig.2.
3. All terms and symbols are consistent with ANSI/IEEE C62.35.
4. For bidirectional type having V_R of 10 volts and less, the I_R should be doubled.

TVS Diodes

Transient Voltage Suppression Diodes

P4SMF Series

I-V Curve Characteristics

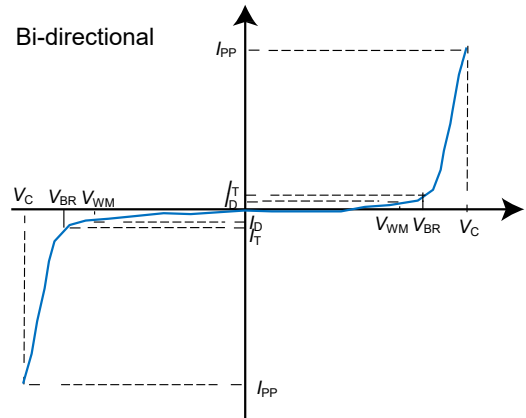
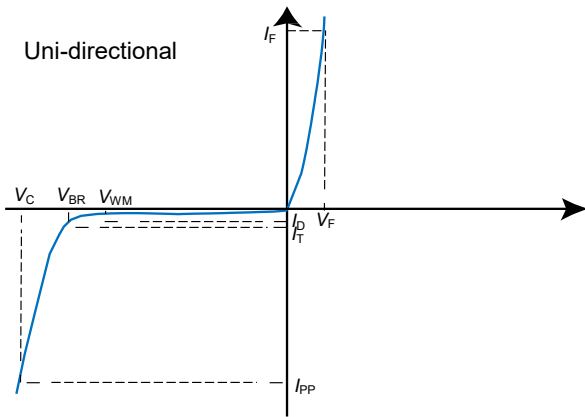

Performance Curve for Reference ($T_A=25^\circ\text{C}$ unless otherwise noted)

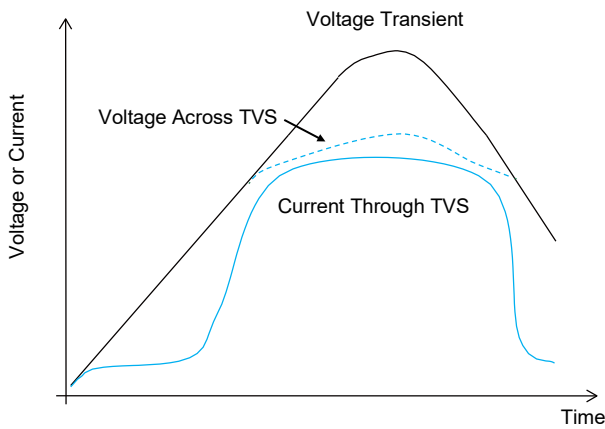

FIGURE 1 TVS Transients Clamping Waveform

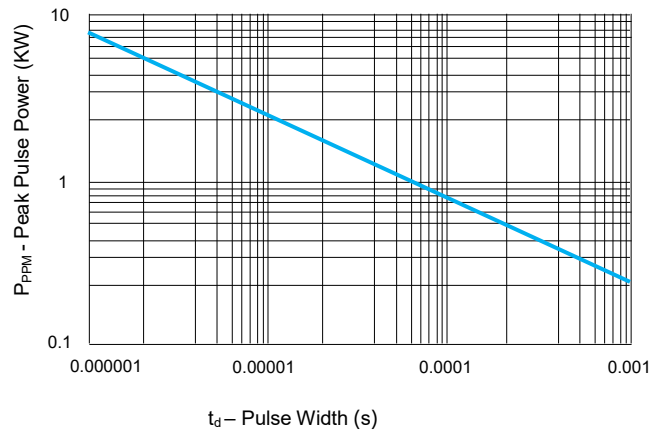

FIGURE 2 Peak Pulse Power Rating Curve

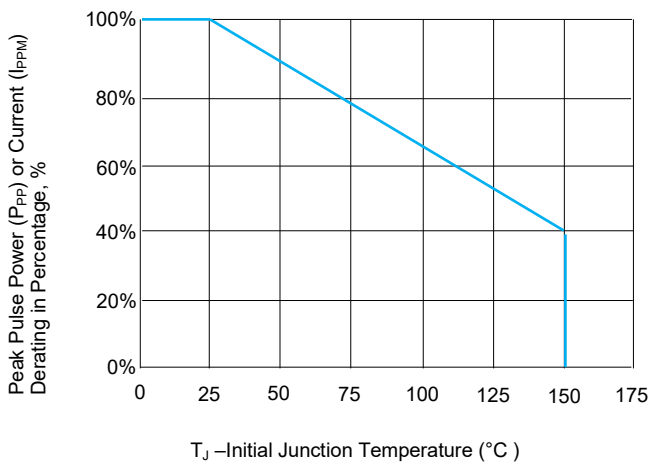

FIGURE 3 Peak Pulse Power Derating Curve

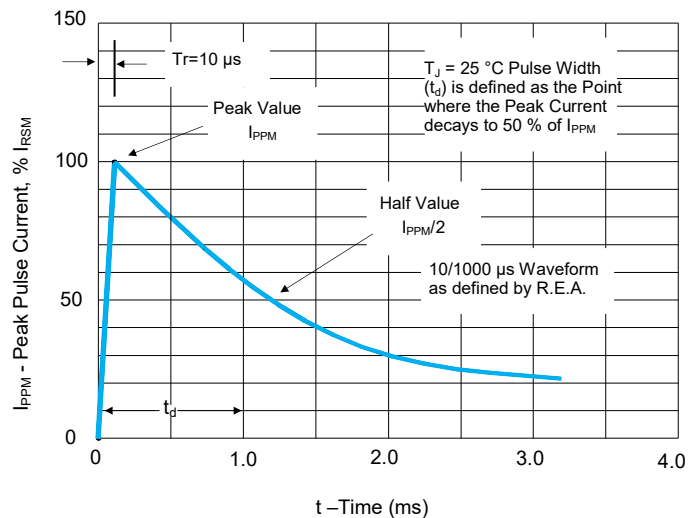

FIGURE 4 Pulse Waveform - 10/1000 μs

TVS Diodes

Transient Voltage Suppression Diodes

P4SMF Series

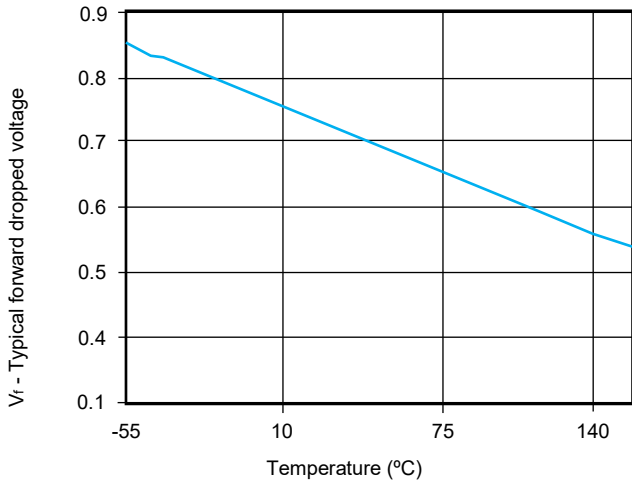

FIGURE 5 Forward Voltage

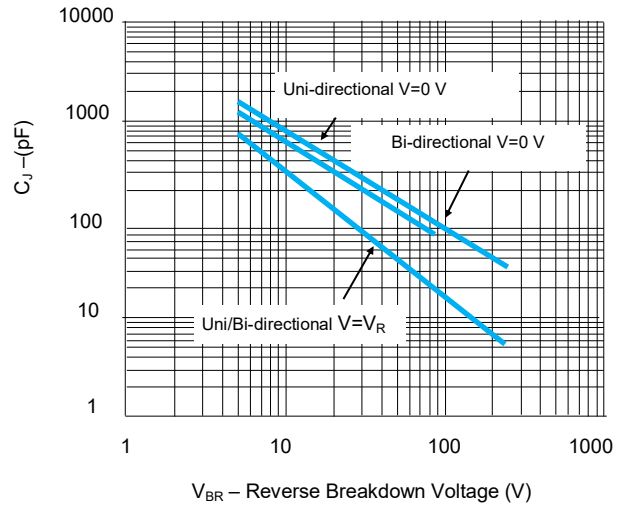

FIGURE 6 Typical Junction Capacitance

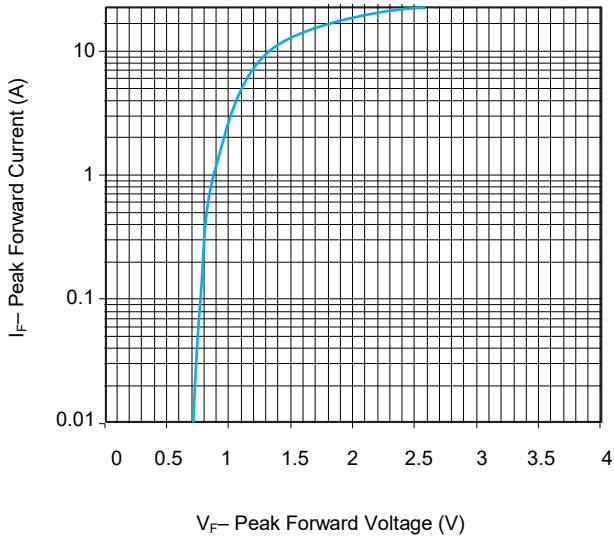

FIGURE 7 Peak Forward Drop vs Peak Forward Current (Typical Values)

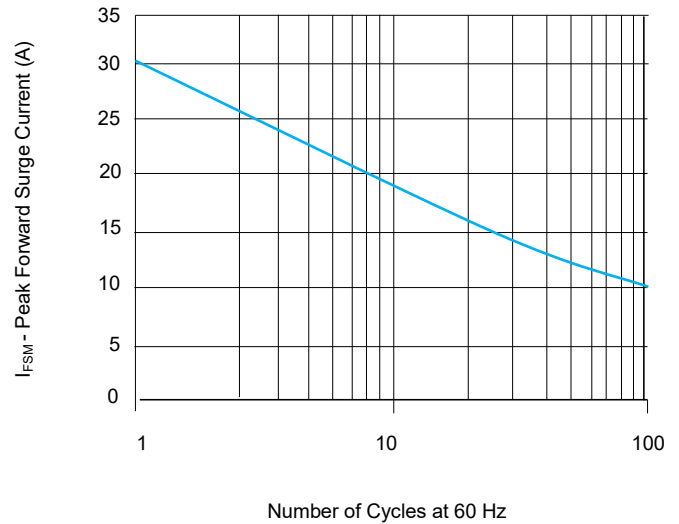

FIGURE 8 Maximum Non-Repetitive Forward Surge Current Uni-Directional only

Environmental Specifications

High Temp. Storage	JESD22-A103
HTRB	JESD22-A108
Temperature Cycling	JESD22-A104
MSL	JEDEC-J-STD-020, Level 1
H3TRB	JESD22-A101
RSH	JESD22-A111

Physical Specifications

Case	SOD-123FL plastic over glass passivated junction
Polarity	Color band denotes cathode except bipolar
Terminal	Matte tin-plated leads, solderable per JESD22-B102

Soldering Parameters

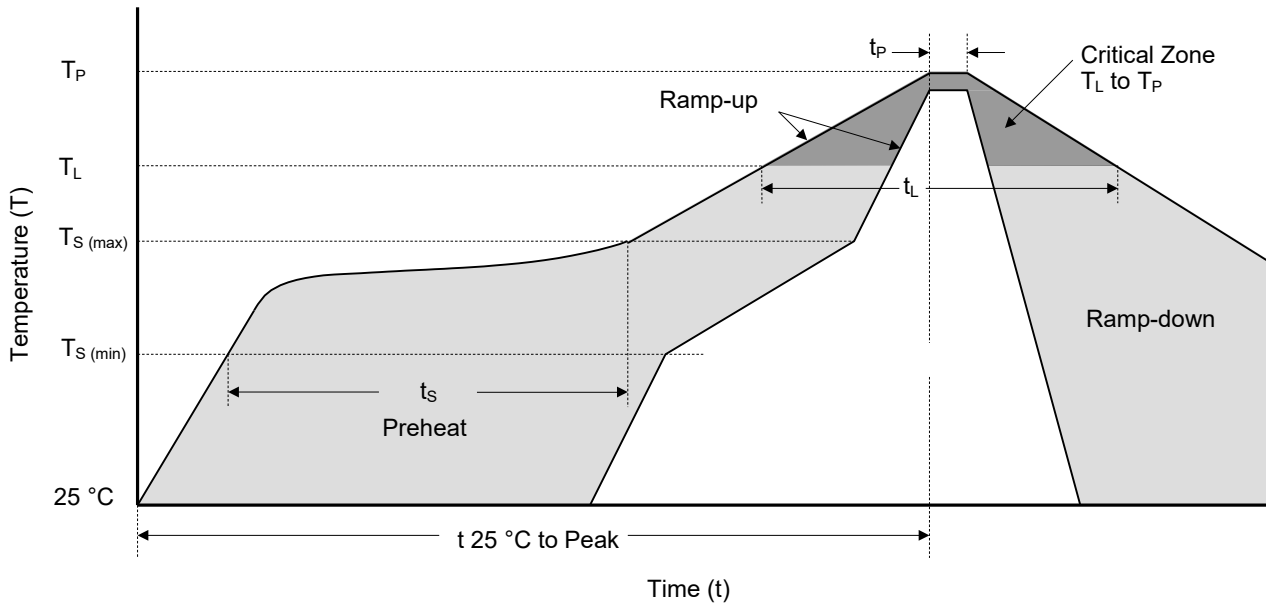

Reflowing Condition

Reflow Soldering Parameters		Lead-Free Assembly
Pre-heat	Temperature Min ($T_{S(min)}$)	150 °C
	Temperature Max ($T_{S(max)}$)	200 °C
	Time (min to max) (t_s)	60 ~ 120 seconds
Average Ramp Up Rate (Liquidus Temp (T_L) to Peak)		3 °C / second max.
$T_{S(max)}$ to T_L Ramp-up Rate		3 °C / second max.
Reflow	Temperature (T_L) (Liquidus)	217 °C
	Time (min to max) (t_L)	60 ~ 150 seconds
Peak Temperature (T_P)		260 ^{+0/-5} °C
Time of within 5 °C of Actual Peak Temperature (t_P)		20 ~ 40 seconds
Ramp-down Rate		6 °C / second max.
Time from 25 °C to Peak Temperature		8 Minutes max.
Do Not Exceed		260 °C

TVS Diodes

Transient Voltage Suppression Diodes

P4SMF Series

Packaging Information

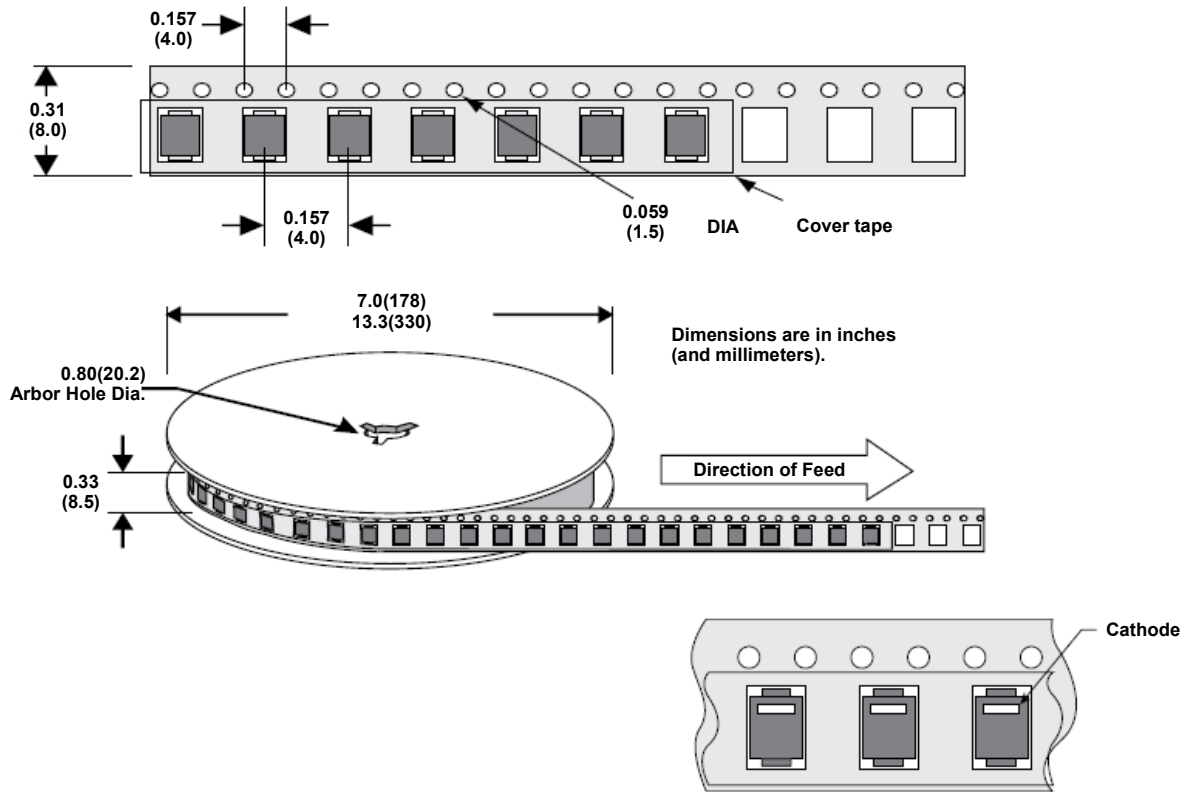

Part Number	Package	QTY' s (Reel)	Packaging Option	Packaging Specification
P4SMFXXX	SOD-123FL	3000 PCS	Tape & Reel – 8 mm tape/7" reel	EIA RS-481

Glossary

Item	Description
V_C	Clamping Voltage Voltage across TVS in a region of low differential resistance that serves to limit the voltage across the device terminals.
V_R	Reverse Stand-off Voltage Maximum voltage that can be applied to the TVS without operation. NOTE : It is also shown as V_{WM} (maximum working voltage (maximum d.c. voltage)) and known as rated stand-off voltage (V_{SO}).
I_R	Reverse Leakage Current Current measured at V_R . NOTE : Also shown as I_D for stand-by current.
V_{BR}	Breakdown Voltage Voltage across TVS at a specified current I_T in the breakdown region.
I_{PPM}	Rated Random Recurring Peak Impulse Current Maximum-rated value of random recurring peak impulse current that may be applied to a device.
$P_{M(AV)}$	Rated Average Power Dissipation Maximum-rated value of power dissipation resulting from all sources, including transients and standby current, averaged over a short period of time.
P_{PPM}	Rated Random Recurring Peak Impulse Power Dissipation Maximum-rated value of the product of rated random recurring peak impulse current (I_{PPM}) multiplies by specified maximum clamping voltage (V_C).
C_J	Capacitance Capacitance across the TVS measured at a specified frequency and voltage.
V_{FS}	Peak Forward Surge Voltage Peak voltage across an TVS for a specified forward surge current (I_{FS}) and time duration. NOTE : Also shown as V_F .
I_{FS}	Forward Surge Current Pulsed current through TVS in the forward conducting region. NOTE : Also shown as I_F .
$\alpha_{V(BR)}$	Temperature Coefficient of Breakdown Voltage The change of breakdown voltage divided by the change of temperature.
I_{PP}	Peak pulse Current Peak pulse current value applied across the TVS to determine the clamping voltage V_C for a specified wave shape.
I_T	Pulsed D.C. Test Current Test current for measurement of the breakdown voltage V_{BR} . This is defined by the manufacturer and usually given in milliamperes with a pulse duration of less than 40 ms. NOTE : Also shown as I_{BR} .

—(GB-T 18802.321 / IEC 61643-321 / JESD210A)



ATTENTION

Usage

1. TVS must be operated in the specified ambient temp.
2. Do not clean the TVS with strong polar solvent such as ketone, esters, benzene and halogenated hydrocarbon, to avoid damaging the encapsulating layer.
3. Please do not apply severe vibration, shock or pressure to TVS, to avoid element cracking.

Replacement

1. If TVS is visually damaged, please replace it.
2. TVS is a non-repairable product. For safety sake, please use equivalent TVS for replacement.

Storage

1. Storage Temp. Range: (-55 to 150) °C.
2. Do not store the TVS at the high temp., high humidity or corrosive gas environment, to avoid influencing the solder-ability of the lead wires. The product shall be used up within 1 year after receiving the goods.

Environmental Conditions

1. TVS should not be exposed to the open air, nor direct sunshine.
2. TVS should avoid rain, water vapor or other condition of high temp. and high humidity.
3. TVS should avoid sand dust, salt mist, or other harmful gases.

Max. Typical Capacitance of TVS

The typical capacitance of TVS is listed in the specifications. Designers may refer to it when designing TVS in High frequency circuit.

Installation Mechanical Stress

1. Do not knock TVS when installing, to avoid mechanical damage.
2. Please do not apply severe vibration, shock or pressure to TVS, to avoid surface resin or element cracking.

Transient Voltage Suppressor (Surface Mount) Features Overview

Package Type									Series
DO-221AC	○	○	○	○	○	SMA6L	○	○	○
DO-214AA	○	○	○	○	○	○	SACB	SMBJ	P6SMB
DO-214AB	○	○	○	○	○	○	○	○	○
DO-214AC	○	○	SMAJ	P4SMA	SMA6J	○	○	○	○
SOD-123FL	SMF	P4SMF	○	○	○	○	○	○	○
SMT0-218	○	○	○	○	○	○	○	○	○
Product Outline (mm)									
V_R / V_{WM} (V) Reverse Stand-off Voltage	5.0 ~ 250	5.0 ~ 85	5.0 ~ 440	5.8 ~ 468	5.0 ~ 250	5.0 ~ 50	5.0 ~ 440	5.8 ~ 512	
P_{PPM} (W) (10/1000 μs) Rated Peak ImPulse Power Dissipation	200		400		600	500	600		
I_{PPM} (kA) (8/20 μs) Rated Peak ImPulse Current					○				
Operating Temperature (°C)	-55 to +150								

Transient Voltage Suppressor (Surface Mount) Features Overview

Package Type	Series									
	DO-221AC	DO-214AA	DO-214AB	DO-214AC	SOD-123FL	SMT0-218	SPC1	SPC3	SPC6	SPC10
	○	○	○	○	○	○	○	○	○	○
	○	○	○	○	○	○	○	○	○	○
	SMCJ	1.5SMC	3.0SMCJ	SMDJ	5.0SMDJ					
	○	○	○	○	○					
	○	○	○	○	○					
	○	○	○	○	○	SPC1	SPC3	SPC6	SPC10	
Product Outline (mm)										
V_R / V_{WM} (V) Reverse Stand-off Voltage	5.0 ~ 440	5.8 ~ 512	5.0 ~ 440	12 ~ 170	380 / 430	66	58 ~ 76	58 ~ 86		
P_{PPM} (W) (10/1000 μ s) Rated Peak ImPulse Power Dissipation	1500	3000	5000							
I_{PPM} (kA)(8/20 μs) Rated Peak ImPulse Current						1	3	6	10	
Operating Temperature (°C)		-55 to +150					-55 to +125			

Transient Voltage Suppressor (Axial Lead) Features Overview

Package Type	Series																
	DO-201	DO-41	DO-15	P600	Radial lead	1.5KE	LCE										
	○	○	○	○	○	○	○	○	○	○	○	○	○	○	○	○	
	P4KE	○	○	○	○	○	○	○	○	○	○	○	○	○	○	○	
	○	SAC	P6KE	○	○	○	○	○	○	○	○	○	○	○	○	○	
	○	○	○	○	○	○	○	5KP	15KPA	20KPA	30KPA	○	○	○	○	○	
	○	○	○	○	○	○	○	○	○	○	○	SPCL1	SPCL3	SPCL6	SPCL10	SPCL15	SPCL20
Product Outline (mm)																	
V_R / V_{WM} (V) Reverse Stand-off Voltage	5.8 ~ 468	5.0 ~ 50	5.8 ~ 512	5.8 ~ 512	6.5 ~ 90	5.0 ~ 250	17 ~ 280	20 ~ 300	28 ~ 360	76	15 ~ 430	30 ~ 430	15 ~ 530	58 ~ 380	16 ~ 76		
P_{PPM} (W) (10/1000 μ s) Rated Peak ImPulse Power Dissipation	400	500	600	1500	5000	15000	20000	30000					○				
I_{PPM} (kA)(8/20 μ s) Rated Peak ImPulse Current					○					1	3	6	10	15	20		
Operating Temperature (°C)					-55 to +150									-55 to +125			